

VEK-F-30352-000
SHT 1.1

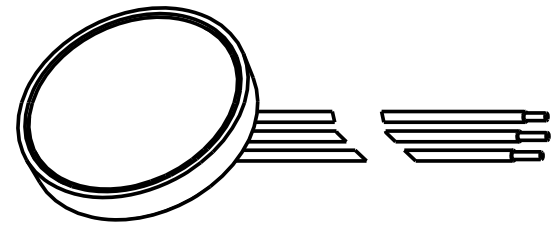
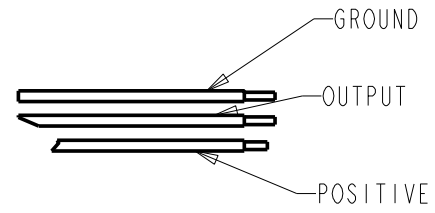
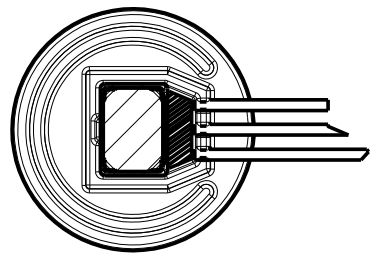
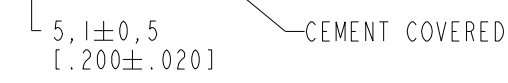
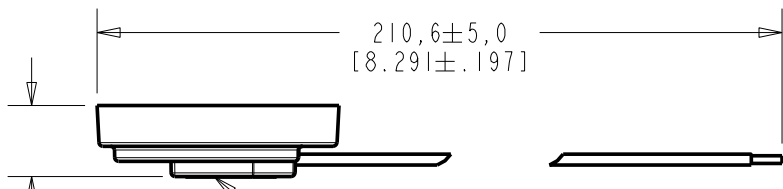
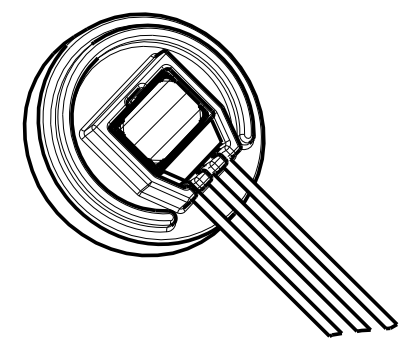
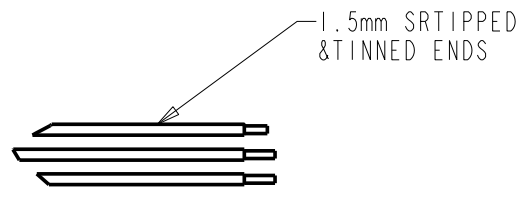
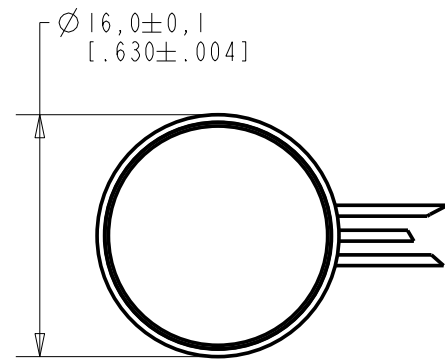

WIRE COLOR		WEIGHT GRAMS
POSITIVE	OUTPUT	t. b. d
RED	WHITE BLACK	

DIMENSIONS IN MILLIMETERS [INCHES]

Revision	C.O. #	Implementation Date	RELEASE LEVEL	REVISION
C	C10107779	8-20-08	Active	C
B	C10107752	8-12-08		
A	C10107373	6-11-08		

KNOWLES ELECTRONICS
ITASCA, ILLINOIS U.S.A.

SCALE: 2:1	DR. BY TT	DATE 6-11-08
DO NOT SCALE DRAWING	CK. BY GJP	DATE 6-17-08
TITLE WATERPROOF MICROPHONE & CABLE	APP. BY GJP	DATE 6-17-08
OUTLINE DRAWING	VEK-F-30352-000 SHT 1.1	

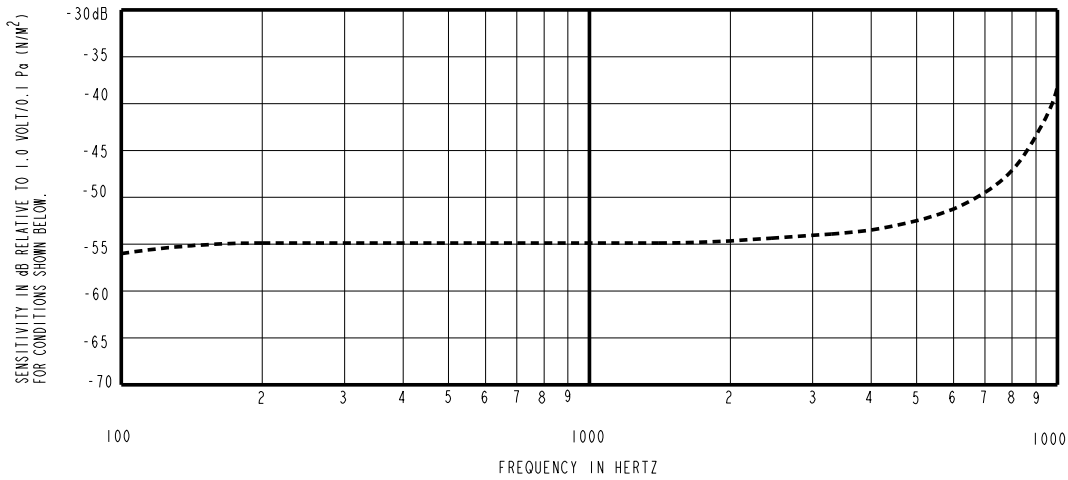

FREQUENCY	SENSITIVITY			DEVICE CONFORMITY	
	MIN.	NOM.	MAX.	RANGE OF DEVIATION FROM 1KHz	
100	---	-56.0	---	-4.0	+2.0
1000	-58.0	-55.0	-52.0	0.0	0.0
10000	---	-38.0	---	+12.0	+22.0

NOTES:

1. MICROPHONE TO BE FUNCTION WITH 10 VDC SUPPLY.
2. SENSITIVITY VALUES INDICATED ON THIS SPECIFICATION ARE VALID AT 50% HUMIDITY.
3. TEST CONDITIONS:
SEAL PRODUCT TO 74 dB SPL SWEPT
SOUND FIELD CREATED BY VOICE APERTURE.
ARTIFICIAL VOICE:
B & k 4227 MOUTH SIMULATOR.
4. FOR MICROPHONE CAPSULE SPEC. SEE DRAWING EK-23132-C36 SHEET 2.1.
5. SURVIVES 20m SUBMERSION BASED ON QUALIFICATION TESTING;
100% TEST 30 MINUTES 1m SUBMERSION; SENSITIVITY WITHIN
3dB OF INITIAL SENSITIVITY AFTER DRIED FOR 30 MINUTES AT ROOM TEMPERATURE.

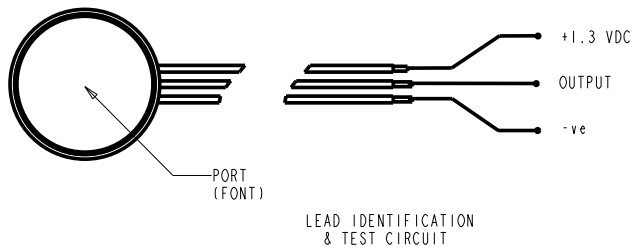

KNOWLES ELECTRONICS
ITASCA, ILLINOIS U.S.A.

Revision	C.O. #	Implementation Date	RELEASE LEVEL	REVISION
C	C10107779	8-20-08	Active	C
B	C10107752	8-12-08		
A	C10107373	6-11-08		

WHEN TEST LIMITS ARE USED TO ESTABLISH INCOMING INSPECTION ACCEPTANCE/REJECTION CRITERIA, CORRELATION OF TEST EQUIPMENT WITH KNOWLES IS ALSO REQUIRED FOR ELIMINATION OF EQUIPMENT AND TEST METHOD VARIATION		DR. BY	DATE
		TT	6-11-08
		CK. BY	DATE
		GJP	6-17-08
		APP. BY	DATE
		GJP	6-17-08

TITLE: **WATERPROOF MICROPHONE & CABLE VEK-F-30352-000**
PERFORMANCE SPECIFICATION **SHT 2.1**