

RAF-32873-000

SHT 1.1

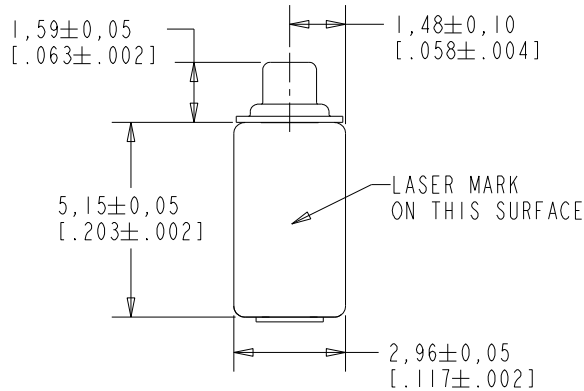

NOTE:

- 1 A POSITIVE GOING VOLTAGE AT TERMINAL 2, RELATIVE TO TERMINAL 1, CAUSES A DECREASE IN PRESSURE AT THE SOUND OUTLET.
- 2 LOCATED FROM TWO SURFACES FOR CUSTOMER CONVENIENCE. ONLY APPLICABLE FROM ONE SURFACE.
- 3 DIMENSION TO APPROXIMATE CENTER OF TERMINAL PAD.

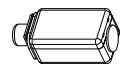
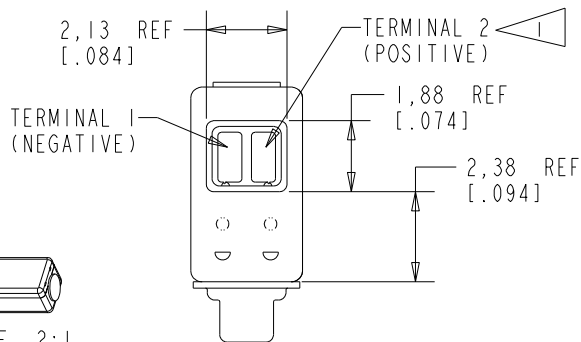
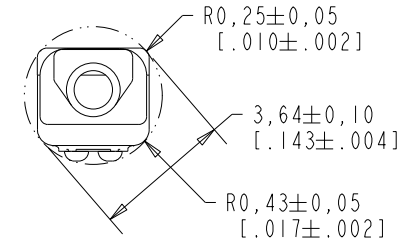
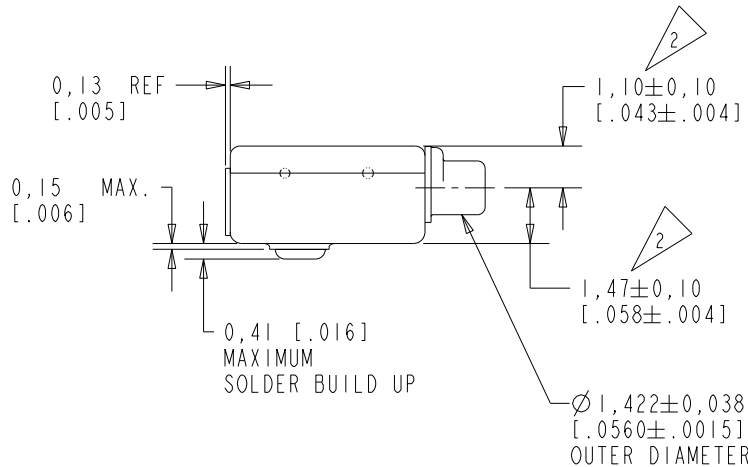
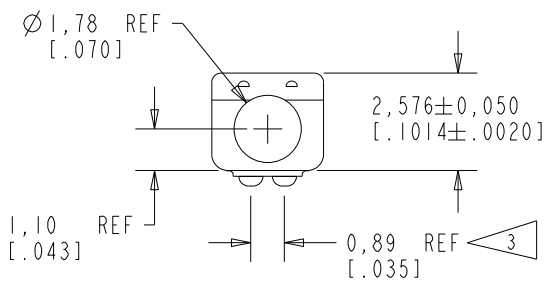

SCALE 2:1

NOMINAL WEIGHT  
.16 GRAMS

DIMENSIONS IN MILLIMETERS [INCHES]

Revision	C.O. #	Implementation Date	RELEASE LEVEL	REVISION
B	PI0000842	10-14-16	Active	B
A	CI0116956	10-20-15		

SCALE: 5:1		DR. BY: SSUN	DATE: 10-20-15
DO NOT SCALE DRAWING			
TITLE: RECEIVER		RAF-32873-000	
OUTLINE DRAWING		SHT 1.1	
		CK. BY: GJP	DATE: 10-21-15
		APP. BY: GJP	DATE: 10-21-15

**KNOWLES CORPORATION**

RAF-32873-000  
SHT 1.2

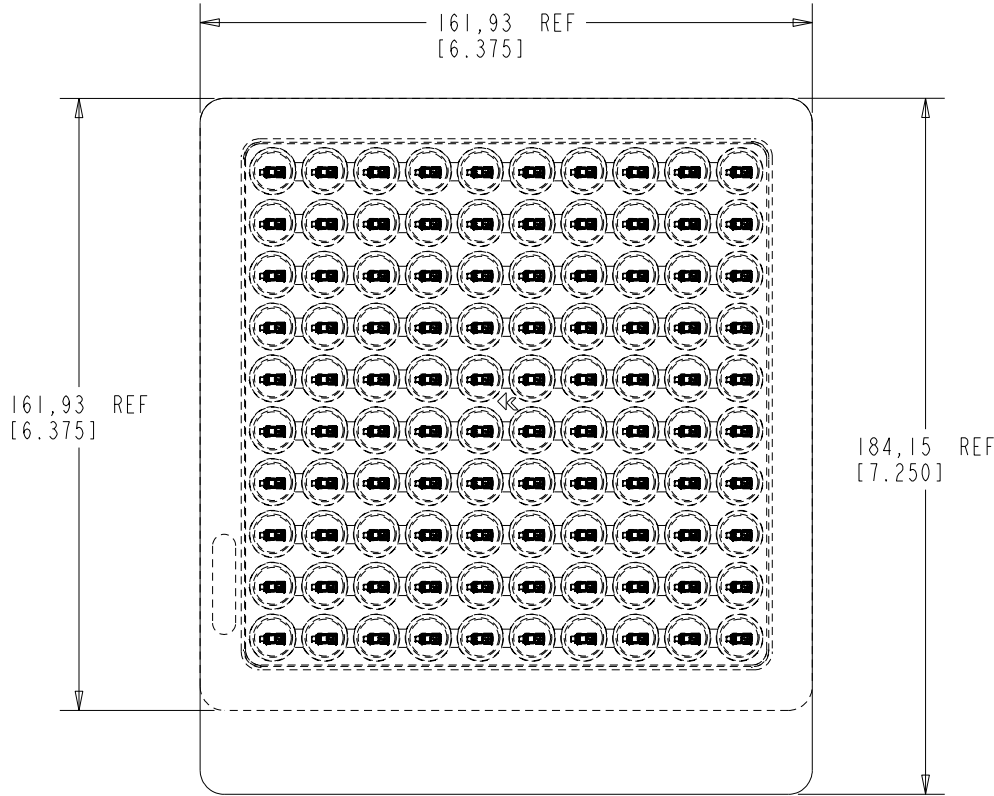

- NOTE:
1. PACKAGE MATERIAL INCLUDES A TRAY AND A COVER.
  2. 100 CAVITIES ON 1 TRAY, 1 PRODUCT IN EACH CAVITY.
  3. MATERIALS ARE ROHS COMPLIANT.
  4. NO SLOT WHEN COVER MATES WITH TRAY.
  5. THE RECEIVER ORIENTATION MAY VARY IN THE BUBBLE PACK.

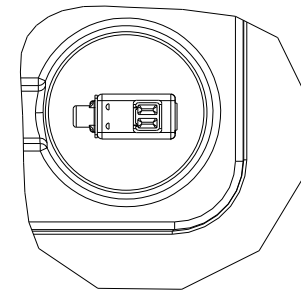

SCALE 2:1

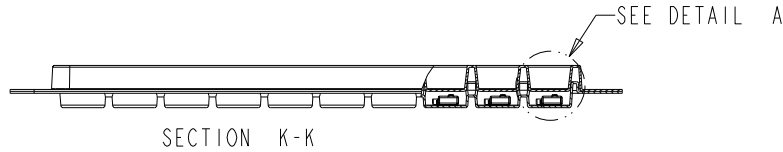

SECTION K-K

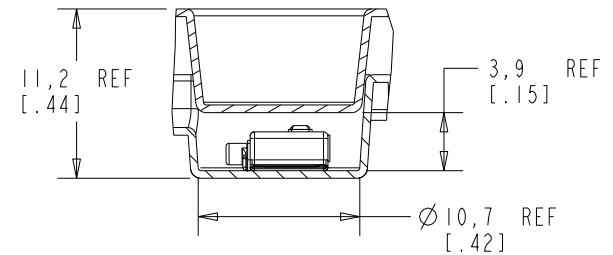

DETAIL A  
SCALE 2:1

DIMENSIONS IN MILLIMETERS [INCHES]

Revision	C.O. #	Implementation Date	RELEASE LEVEL	REVISION
B	PI0000842	10-14-16	Active	B
A	CI0116956	10-20-15		

SCALE: 5:1		DR. BY: SSUN	DATE: 10-20-15
DO NOT SCALE DRAWING			
TITLE: RECEIVER	RAF-32873-000	GJP	10-21-15
OUTLINE DRAWING	SHT 1.2	APP. BY: GJP	DATE: 10-21-15

**KNOWLES CORPORATION**

THIS IS A MAGNETIC BALANCED ARMATURE RECEIVER INTENDED FOR USE IN EARPHONE APPLICATIONS. THIS RECEIVER HAS A BACK VENT.

TYPE 1 DAMPING

RAF-32873-000

SHEET 2.1

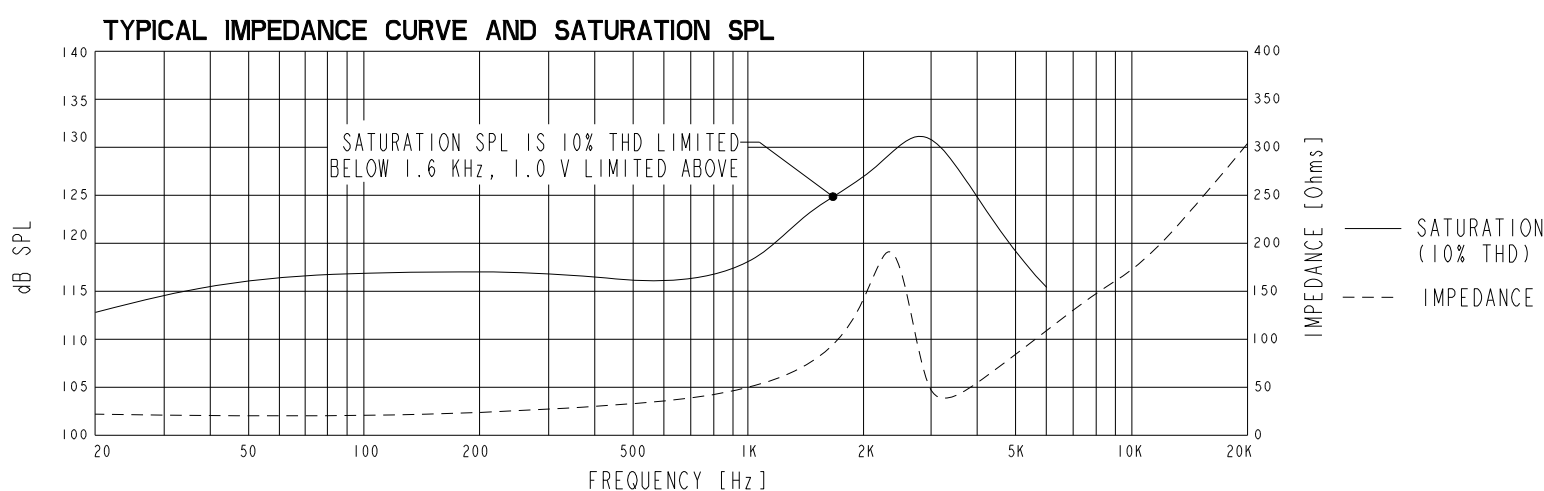
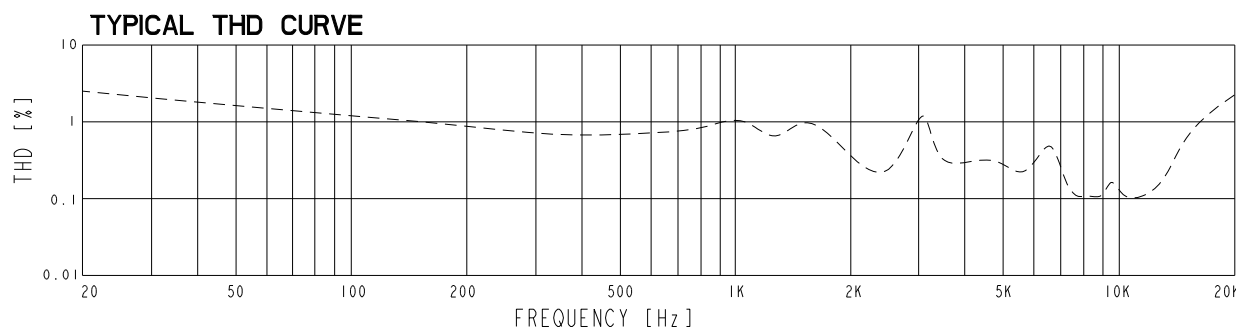
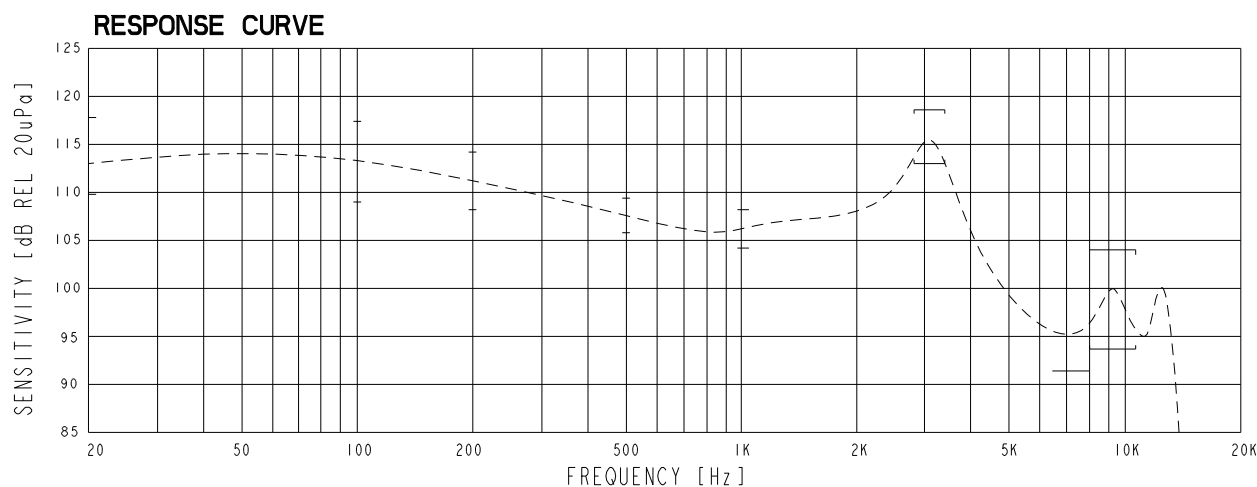

**ACOUSTICAL**

SENSITIVITY DEVICE WILL PRODUCE THE SPL LISTED BELOW WITH THE TEST CONDITIONS DESCRIBED IN TABLE 3. NOMINAL SENSITIVITY AT 1 kHz IS dB RELATIVE TO 20μPa. ALL OTHER VALUES IN dB RELATIVE TO THE SENSITIVITY AT 1 kHz.

LIMIT TYPE	FREQUENCY (Hz)	MINIMUM	NOMINAL	MAXIMUM
REL	20	+3.5	+7.5	+11.5
REL	100	+3.0	+7.0	+11.0
REL	200	+2.0	+5.0	+8.0
REL	500	-0.5	+2.0	+3.5
REF	1000	-2.0	106.2	+2.0
PEAK	2850-3450	+6.5	+9.5	+12.5
VALLEY	6400-8000	-15.0	---	---
PEAK	8000-11000	-12.0	-7.0	-2.0

TABLE 1.

TOTAL HARMONIC DISTORTION DEVICE WILL NOT EXCEED TOTAL HARMONIC DISTORTION LEVELS LISTED BELOW.

FREQUENCY (Hz)	DRIVE (Vrms)	LIMIT (%)
50	0.115	5.8
1/3 PEAK 1 (TYP. 1050)	0.115	6.8
1/2 PEAK 1 (TYP. 1575)	0.115	4.8
1/3 PEAK 1 (TYP. 1050)	0.324	9.5
1/2 PEAK 1 (TYP. 1575)	0.324	9.5

TABLE 2.

**TEST CONDITIONS**

NOMINAL SOURCE VOLTAGE	0.115 Vrms
SOURCE IMPEDANCE	< 1 Ω
TUBING	TUBELESS, DIRECT TO 711 COUPLER
COUPLER CAVITY	IEC 60318-4 (IEC 711)

TABLE 3.

**ELECTRICAL**

DC RESISTANCE	22.0 Ω ±10%
IMPEDANCE @ 500 Hz	33.0 Ω ±15%
IMPEDANCE @ 1 kHz	50.0 Ω ±15%
INDUCTANCE @ 500 Hz	7.8 mH TYPICAL

TABLE 4.

ISOLATION: THE CASE WILL BE ELECTRICALLY ISOLATED FROM THE COIL CIRCUIT

**ELECTRICAL-ACOUSTICAL**

TYPICAL PERFORMANCE AT 1 kHz

SENSITIVITY TO 100 mV	105 dB
SENSITIVITY TO 1 mW	112 dB
MAX. SPL (10% THD)	117 dB
MAX. DRIVE VOLTAGE	1.0 V
THD AT 94 dB SPL	0.4%
THD AT 100 dB SPL	0.6%

TABLE 5.

**MECHANICAL**

PORT LOCATION: 12S

SOLDER TYPE: ROHS COMPLIANT SAC305

TEMPERATURE

OPERATING: SENSITIVITY WILL NOT VARY MORE THAN +1/-3 dB FROM 0°C TO 63°C  
STORAGE: -40°C TO 63°C

**KNOWLES CORPORATION**

Revision	C.O. #	Implementation Date	RELEASE LEVEL	REVISION
B	PI0000842	10-14-16	Active	B
A	CI0116956	10-20-15		
WHEN TEST LIMITS ARE USED TO ESTABLISH INCOMING INSPECTION ACCEPTANCE/REJECTION CRITERIA, CORRELATION OF TEST EQUIPMENT WITH KNOWLES IS ALSO REQUIRED FOR ELIMINATION OF EQUIPMENT AND TEST METHOD VARIATION			DR. BY	DATE
TITLE: RECEIVER PERFORMANCE SPECIFICATION			SSUN	10-20-15
			RAF-32873-000	
SHT 2.1			CK. BY	DATE
			GJP	10-21-15
			APP. BY	DATE
			GJP	10-21-15

**APPLICATION NOTES:**

1. HANDLING AND ASSEMBLY:  
LIMIT APPLIED FORCE TO LEVELS SHOWN IN FIGURE BELOW TO AVOID DAMAGE.  
DAMPER SURFACE MUST BE KEPT CLEAN AND UNOBSTRUCTED DURING APPLICATION TO ACHIEVE SPECIFIED PERFORMANCE .  
CHANGE TO AIR FLOW THROUGH DAMPING SCREW WILL CAUSE A RESPONSE CHANGE AT LOW FREQUENCIES. DO NOT ABRASE OR COVER MATERIAL IN FINAL APPLICATION.
2. BACK VOLUME:  
"BACK VOLUME" OF HOUSING/SHIELD AFTER ASSEMBLY SHOULD NOT BE LESS THAN 0.02 CC. TO ACHIEVE SPECIFIED RESPONSE, "BACK VOLUME" SMALLER THAN 0.02 CC MAY CAUSE A RESPONSE CHANGE AT LOW FREQUENCIES.
3. TERMINAL AND SOLDERING:  
THE INTERNAL COIL WIRE OF THE TRANSDUCER IS TERMINATED TO THE EXTERNAL SOLDER PADS, WHEN SOLDERING EXTERNAL WIRES TO SOLDER PAD, PLEASE TAKE CARE NOT TO DAMAGE THE EXISTING INTERNAL WIRE ON PAD.
4. SOLDER PAD PULL FORCE:  
SOLDER PADS ARE DESIGNED TO WITHSTAND 5 N OF PULL FORCE.
5. IN ORDER TO MINIMIZE DEVICE DAMAGE:  
DO NOT INSERT ANY OBJECT INTO THE PORT HOLE OF DEVICE.  
PREVENT ANY LIQUIDS FROM ENTERING INSIDE OF RECEIVER.  
TAKE CARE TO AVOID DROPPING UNPROTECTED RECEIVER ONTO HARD SURFACES, DROPPING UNPROTECTED RECEIVER ONTO HARD SURFACES MAY CAUSE INTERNAL DAMAGE, REDUCING PERFORMANCE.

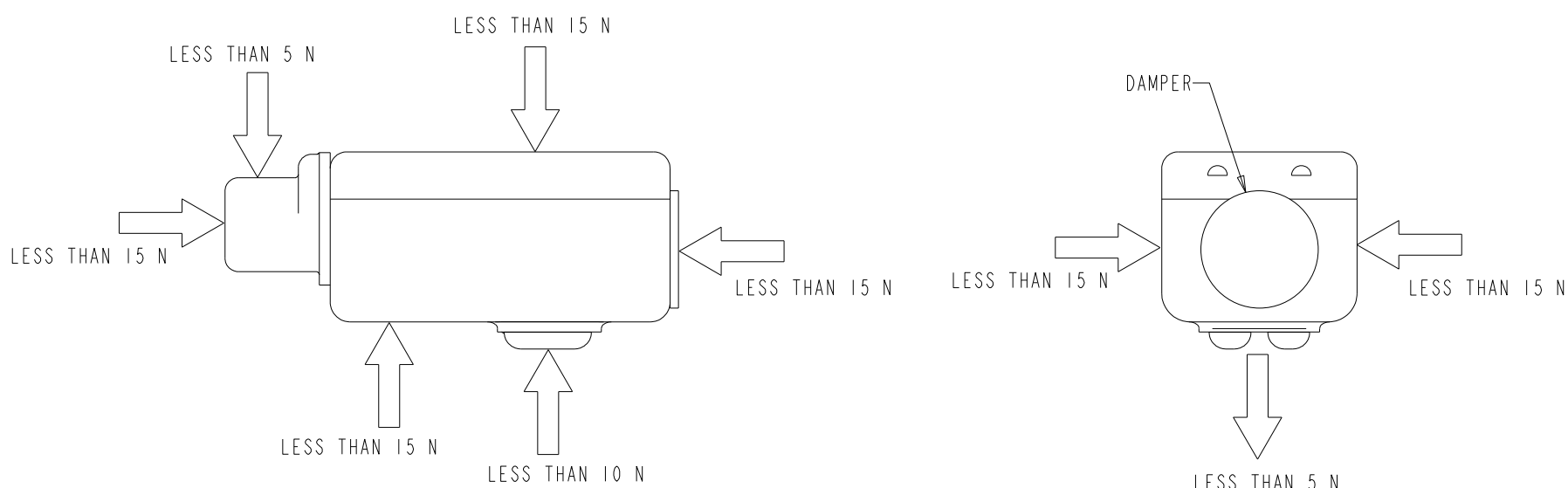
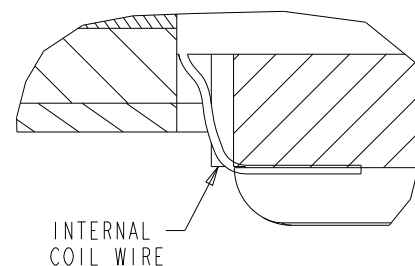

**RELIABILITY TEST**

STANDARDS/SPECIFICATIONS	TEST ITEM	TEST CONDITIONS	ACCEPTANCE CRITERIA
QAP-8040	HALT (Highly Accelerated Life Test)	63°C at 95% RH +9dB drive at resonance for 2 weeks	Sensitivity change <3dB at 1000 Hz
IEC 68-2-38	Composite Temp & Humidity Cyclic Test	Test 2b (10 cycles of 24 hours each) 25°C / 80-100% RH for 3 h 65°C / 90-100% RH for 5 h -10°C / 0% RH for 5 h	Sensitivity change <3dB at 1000 Hz
QAP-8100	Thermal Shock	5 cycles: -40°C to +63°C, 15 minute soaks, <30 sec. transition	Sensitivity change <3dB at 1000 Hz
QAP-8640	Artificial Sweat Test	10 days exposure to sweat vapor at 38°C	Sensitivity change <3dB at 1000 Hz
QAP-8070	Solder / De-Solder Cycle Test	Tip temp 750F (400°C): 5 cycles 2 seconds / pad	Sensitivity change <1dB at 1000 Hz
QAP-8200	Mechanical Shock	Drop from progressively higher heights until failure. "Failure" means that sensitivity changes >3dB from initial, or THD at nominal drive at 1/3 resonance > 10%, or THD at nominal drive at 1/2 resonance > 20%.	>90% survival rate @ 14.1 kG shock level.
IEC 68-2-64	Vibration Stress (with Packaging Material)	10 Hz - 60 Hz w / const. amp of 3.5 mm 60 Hz - 150 Hz w / const. acc of 30 G sweep 10 oct / min, 10 min in each axis	Sensitivity change <1 dB at 1000 Hz
QAP 9130	Powered Salt Fog	2 weeks exposure to 35°C salt fog chamber with salt deposition 20-50g/sq.m/24 hours. powered with AC 0.289 Vrms @ 1kHz.	DCR test within spec (22.0 Ω ±10%).

NOTE: QAP IS THE ABBREVIATION FOR QUALITY ASSURANCE PROCEDURES. THESE ARE KNOWLES INTERNAL DOCUMENTS TO CONTROL PRODUCT QUALITY.

Revision	C.O. #	Implementation Date	RELEASE LEVEL	REVISION
B	PI0000842	10-14-16	Active	B
A	CI0116956	10-20-15		
WHEN TEST LIMITS ARE USED TO ESTABLISH INCOMING INSPECTION ACCEPTANCE/REJECTION CRITERIA, CORRELATION OF TEST EQUIPMENT WITH KNOWLES IS ALSO REQUIRED FOR ELIMINATION OF EQUIPMENT AND TEST METHOD VARIATION				
TITLE: RECEIVER		RAF-32873-000	DR. BY SSUN	DATE 10-20-15
PERFORMANCE SPECIFICATION		SHT 2.2	CK. BY GJP	DATE 10-21-15
			APP. BY GJP	DATE 10-21-15

**KNOWLES CORPORATION**